

W2

HOW TO PICK OUT YOUR CABLE

Check For Cable Part Number

In most instances, a part number has been stamped on the outer casing of Morse and other manufacturers' push-pull cables. This part number will allow you to identify the specific assembly you need as a replacement, regardless of whether you find a Morse part number or other manufacturers' part number.



Measure End Fitting Thread Size

When you are ordering a cable with bulkhead or clamp type fittings you must measure end fitting thread size to determine proper series. Use the handy Morse identifier to determine whether your cable is:

- 40 Series - with 1/4-28 UNF threads
- 60 Series - with 5/16-24 UNF threads
- 30L Series - have exposed .075 SST core wire
- 30 Series - with 3/16-32 UNF threads

Measure Cable Travel 40 and 60 Series

Once you have determined the proper end fitting and size, you are ready to determine cable travel. Standard cable travels are 2", 3", or 4". Also available in 1" and 5" lengths.

Measure from the end of the rod seal to the midpoint of the bulkhead type fitting thread, or on a clamp type fitting, from the end of the rod seal to the middle of the clamp groove. See illustrations. See dimension chart on W4 and W5.

Measure Cable Length 40 and 60 Series

Standard 40 and 60 series B, C, or BC cables are measured from rod end to rod end, as shown at right.

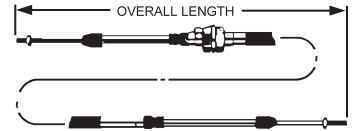
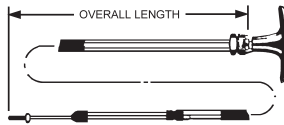

Utility, Vernier and Positive Lock controls with bulkhead or clamp type end fittings are measured from the inside of the cap nut to the rod end, with rod fully extended position as shown at left.

TERMINAL ENDS For CABLES and RODS

FEMALE FINE THREADED CLEVIS

BLACK CLEVIS'S ON PAGE D2



BALL JOINTS

Part Number	Fits Cable Series	Female Fine Thread Size	Male Fine Thread Size	Fits Rod Thickness Size	Our Sequence Number	Per Each
A31799-001	30	3/16	3/16	3/16	735040	\$11.83
A31126	30	3/16	1/4	3/16	734848	13.00
A35242	30	3/16	5/16	3/16	735296	25.51
A29104	40	1/4	1/4	1/4	734528	13.10
A32267	40	1/4	5/16	1/4	735168	18.45
A38491	60	5/16	5/16	5/16	735424	19.57
A29108*	60	5/16	5/16	5/16	734592	24.79
A38490	100	7/16	7/16	7/16	735410	35.71

*Quick Release

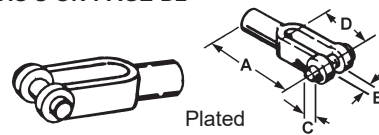

Plated

Part Number	B Fits Lever Thickness	C Fits Pin Hole	A End to Center Of Pin Length	D Throat Length	Our Sequence Number	Per Each
Fits 30 Series 3/16 Female Fine Thread						
A31800	3/16	3/16	1-9/16	1	735104	\$10.31
A31125	9/32	1/4	2	1-1/4	734784	10.76
A33395	11/32	5/16	2-1/4	1-7/16	735232	15.41

Fits 40 Series 1/4 Female Fine Thread						
A29025	9/32	1/4	2	1-1/4	734464	12.68
A42212	11/32	5/16	2-1/4	1-7/16	735744	14.29
A45985	7/16	3/8	2-1/2	1-5/8	736000	40.62

Fits 60 Series 5/16 Female Fine Thread						
A29132-001	11/32	5/16	2-1/4	1-7/16	734656	10.15
A42034	7/16	3/8	2-1/2	1-5/8	735680	25.96

Fits 80 Series 3/8 Female Fine Thread						
A35840	11/32	5/16	2-1/4	1-7/16	735300	43.36



PIVOTS

Part Number	Type	Fits Cable Number	Fits Lever Thickness	Fits Hole Size	Our Sequence Number	Per Each
A31029	Light	30	1/8	1/4	734720	\$8.65
A39110	Medium	40	1/8	1/4	735552	9.99

CLAMPS for CLAMP TYPE CABLES



Cable Number	Type	Fits Cable Series	Fits Hole Size	Hole Center Inches	Our Sequence Number	Per Each
A31509	Light	30	7/32	1	734912	\$1.34
A31532	Medium	40	7/32	1	734976	2.13
A36733	Heavy	60	9/32	1-1/4	735360	3.06

HANDLES FOR UTILITY CABLES



Part Number	Description	For Series	Thread Size	Our Sequence Number	Per Each
305481	Red Knob for PTO Cable	PTO	3/8-24	736147	\$7.72
B44343A1	Red Knob	30	10-32	113927	11.62
B43267 B 1	Black Plastic Knob	Utility	1/4-20	113925	8.91
B41884 B 1	Black Plastic T-Handle	Utility	1/4-20	113920	7.76

CABLE SPECIFICATIONS

Series	Push-Pull Capacity	Wire Core Size	Fine Thd. Rod End	Bulkhead Nut Size	Clamp Diam.
20	Varies	.047"	Wire	5/16-24	5/16"
30L	Varies	.075"	Wire	3/8-24	3/8"
30	40	.075"	10-32	7/16-20	3/8"
40	80	1/8"	1/4-28	5/8-18	1/2"
60	180	3/16"	5/16-24	11/16-16	9/16"

PTO CABLES COMPLETE FOR PTO, THROTTLE, CHOKE, DIESEL SHUTOFF and STOP

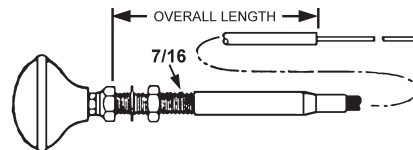

30L PTO CABLES EXTRA LIGHT DUTY Cut these to any length

Length Inches	Part Number	Our Sequence Number	Per Each
60	317010-E9-60	1141065	\$108.19
120	317010-E9-120	1141155	120.79
180	317010-E9-180	1141175	132.94
240	317010-E9-240	1141195	147.19
300	317010-E9-300	1141215	298.93
360	317010-E9-360	1141245	108.09

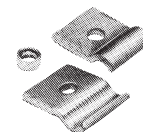

HUB KIT & CONDUIT CLIP KIT For 317010 30L PTO Cables ABOVE

Part Number	Description	Our Sequence Number	Per Each
A302001	For Attaching D302000 Series Cable Conduit Clip Kit	736182	\$8.61

**MORSE REMOTE VALVE CONTROL CABLES For E206301 STACKABLE HEAD
ALL CABLES WITH 2" TRAVEL**

W3

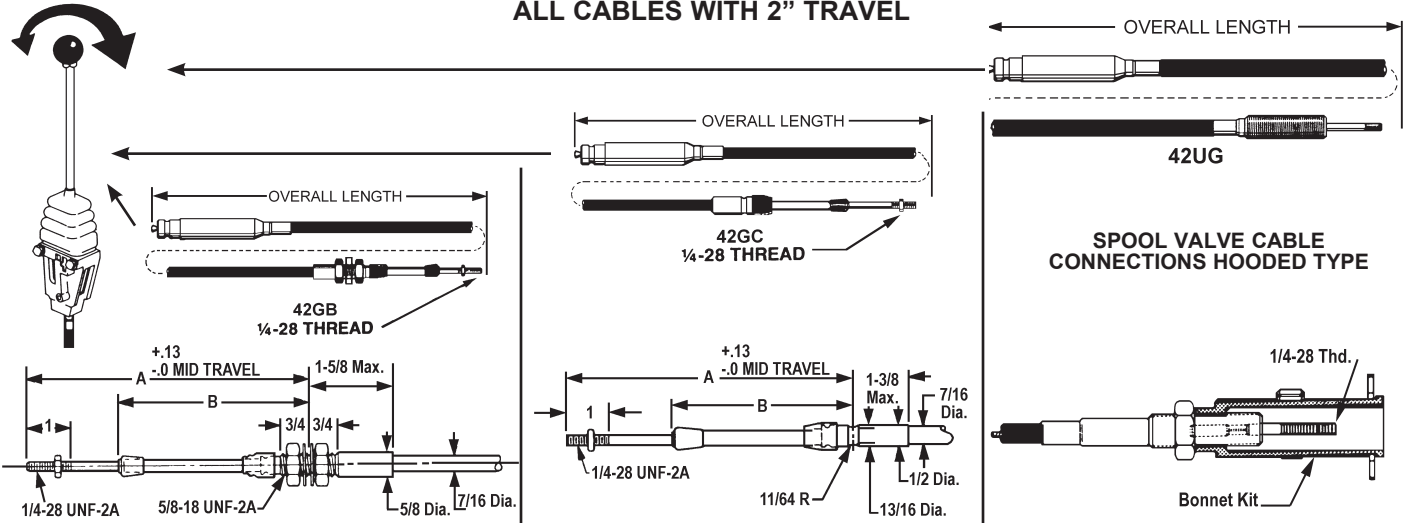

BULKHEAD/VALVE END FOR CLEVIS

CLAMP/VALVE END FOR CLEVIS

**CABLE VALVE BONNET KIT
REQUIRED - SEE BELOW**

Length Inches	Part Number
STANDARD DUTY BULKHEAD TYPE REMOTE SPOOL VALVE CABLE 40 SERIES 2" TRAVEL 1/4" THREAD	
36	302665-2-36
48	302665-2-48
60	302665-2-60
72	302665-2-72
96	302665-2-96
120	302665-2-120
144	302665-2-144
180	302665-2-180

Part Number	
STANDARD DUTY CLAMP TYPE REMOTE SPOOL VALVE CABLE 40 SERIES 2" TRAVEL 1/4" THREAD	
302486-2-36	
302486-2-48	
302486-2-60	
302486-2-72	
302486-2-96	
302486-2-120	
302486-2-144	
302486-2-180	

Part Number	
STANDARD DUTY BONNET TYPE REMOTE SPOOL VALVE CABLE 40 SERIES 2" TRAVEL 1/4" THREAD	
302845-2-36	
302845-2-48	
302845-2-60	
302845-2-72	
302845-2-96	
302845-2-120	
302845-2-144	
302845-2-180	

**40 Series 2" Travel
1-1/4" Thread Standard
Clamp for CUSTOM
HANDLE Remote Spool**

302909-2- Call for Length

42UC
1/4-28 THREAD

**40 Series 2" Travel
1-1/4" Thread Standard
Bulkhead for CUSTOM
HANDLE Remote Spool**

303197-2- Call for Length

**42UB
1/4-28 THREAD**

**STACKABLE REMOTE
VALVE CONTROL HEAD**

VALVE BONNET KITS

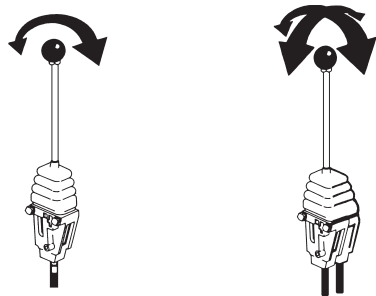

**SINGLE AXIS
E206301**

**DUAL AXIS
308721**

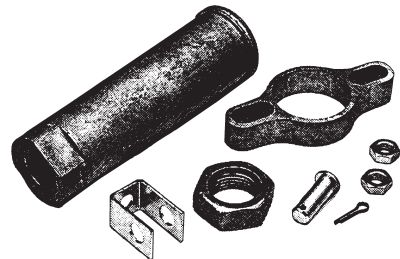

Used in the remote operation of high pressure hydraulic spool valves, the Remote Valve Control is a trim, modular block that can be ganged together to form multi-lever combination sections controlling a number of valve spools. The control is designed for a wide variety of mounting options, depending on the system's requirements. Add to the control a Morse Red-Jaket cable with a bonneted end specifically designed to suit individual valve spools, and you have a remote control system that is sealed to keep out most dirt and other contaminants.

Part Number	Description	Our Sequence Number	Per Each
303418	Commercial Intertech A-20	736207	\$234.70
307489	Commercial Intertech VA20	736216	48.18
303036	Cross 3LR-3CV	736204	30.12
302890	Cross BA, BC, CA, CD	736149	56.24
303032	Energy CVDS, CVP, CVA-2 Gresen 25P, CP, CS, V20, V42	736186	80.47
303034	Rex Roth 30-S2, MP-18	736203	47.36

Attaching Kits for Valves Below

**CLEVIS FOR 40 SERIES 1/4-28 Thread
(Use with Bulk or Clamp Type RV Cable)**

Part Number	Description	Our Sequence Number	Per Each
ALL CONTROL HEADS ARE STACKABLE			
E206301	Control Head Std. Axis 9.8" Handle	113650	\$87.18
308721	Dual Control Head	113652	93.24
206317	Boot for Single Axis	736141	7.46
211336	Boot for Dual Axis	736143	31.95

For Valve Type	Morse Cable Clevis Part Number	Our Sequence Number	Per Each	Pin Diam.	Fits Lever	Female Thread Size
-----	-----	-----	---	---	---	---
CM-11	A45985	736000	40.62	3/8	7/16	1/4-28

MORSE / KONGSBERG CLAMP and CLAMP PUSH-PULL CABLES
CABLES BUILT TO YOUR SPECIFICATIONS - CALL US FOR PRICE QUOTE
PUSH-PULL CABLES MADE HERE TO ORDER ANY LENGTH

BAUM HYDRAULICS IS AN AUTHORIZED MORSE MASTER CABLE ASSEMBLER
 ALL CABLES ARE TESTED TO FACTORY SPECIFICATIONS and **CANNOT BE RETURNED**



Travel Inches	A DIMENSION CLAMP TYPE					B DIMENSION CLAMP TYPE				
	1"	2"	3"	4"	5"	1"	2"	3"	4"	5"
30 SERIES	3-11/16"	5-3/16"	6-11/16"	8-3/16"	9-11/16"	2-5/16"	3-5/16"	4-5/16"	5-5/16"	6-5/16"
40 SERIES	4"	5-1/2"	7"	8-1/2"	10"	2-1/2"	3-1/2"	4-1/2"	5-1/2"	6-1/2"
60 SERIES	4-3/8"	5-7/8"	7-3/8"	8-7/8"	10-3/8"	2-11/16"	3-11/16"	4-11/16"	5-11/16"	6-11/16"
80 SERIES	--	6-11/16"	8-3/16"	9-11/16"	11-11/16"	--	4-1/4"	5-1/4"	6-1/4"	7-3/4"

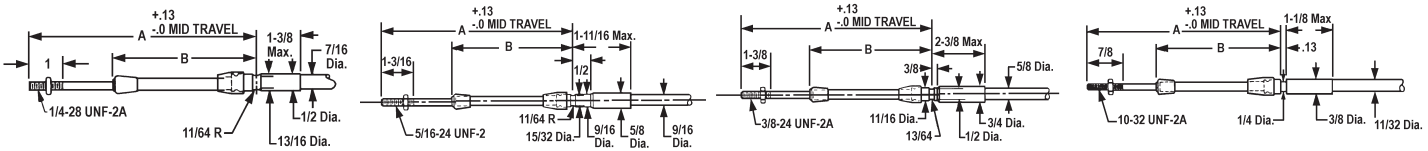

Length, Ins.	40C SERIES ARMORED STRAND CORE		60C SERIES ARMORED STRAND CORE		80C SERIES ARMORED STRAND CORE		30C SERIES SOLID STAINLESS STEEL CORE	
	Part Number	STANDARD DUTY 3" Travel 1/4" Thread	Part Number	HEAVY DUTY 3" Travel 5/16" Thread	Part Number	HEAVY DUTY 3" Travel 3/8" Thread	Part Number	LIGHT DUTY 3" Travel 3/16" Thread
36"	304242-3-36		304262-3-36		38016-3-36		D32377-3-36	
72"	304242-3-72		304262-3-72		38016-3-72		D32377-3-72	
120"	304242-3-120		304262-3-120		38016-3-120		D32377-3-120	
144"	304242-3-144		304262-3-144		38016-3-144		D32377-3-144	
180"	304242-3-180		304262-3-180		38016-3-180		D32377-3-180	
240"	304242-3-240		304262-3-240		38016-3-240		D32377-3-240	
348"	304242-3-348		304262-3-348		38016-3-348		D32377-3-348	

MORSE / KONGSBERG BULKHEAD and BULKHEAD PUSH-PULL CABLES



Travel Inches	A DIMENSION BULKHEAD TYPE					B DIMENSION BULKHEAD TYPE				
	1"	2"	3"	4"	5"	1"	2"	3"	4"	5"
30 SERIES	4-3/8"	5-7/8"	7-3/8"	8-7/8"	10-3/8"	3"	4"	5"	6"	7"
40 SERIES	4-5/8"	6-1/8"	7-5/8"	9-1/8"	105/8"	3-1/8"	4-1/8"	5-1/8"	6-1/8"	7-1/8"
60 SERIES	5-1/16"	6-9/16"	8-1/16"	9-9/16"	11-1/16"	3-3/8"	4-3/8"	5-3/8"	6-3/8"	7-3/8"
80 SERIES	--	7-3/16"	8-11/16"	10-3/16"	11-11/16"	--	4-3/4"	5-3/4"	6-3/4"	7-3/4"

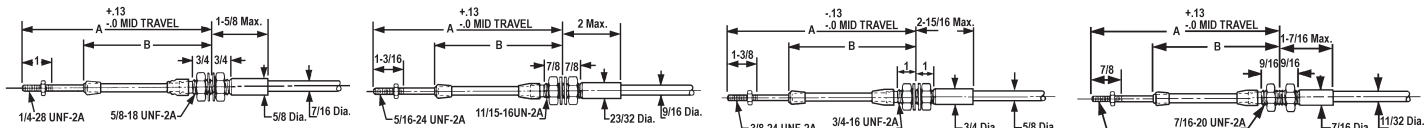

Length, Inc.	40B SERIES ARMORED STRAND CORE		60B SERIES ARMORED STRAND CORE		80B SERIES ARMORED STRAND CORE		30B SERIES SOLID STAINLESS STEEL CORE	
	Part Number	STANDARD Duty-Black Jacket 3" Travel 1/4" Thd.	Part Number	HEAVY DUTY-Black Jacket 3" Travel 5/16" Thd.	Part Number	HEAVY DUTY 3" Travel 3/8" Thd.	Part Number	LIGHT DUTY-Black Jacket 3" Trvl 3/16" Thd.
36"	304241-3-36		304261-3-36		38034-3-36		D36559-3-36	
72"	304241-3-72		304261-3-72		38034-3-72		D36559-3-72	
120"	304241-3-120		304261-3-120		38034-3-120		D36559-3-120	
144"	304241-3-144		304261-3-144		38034-3-144		D36559-3-144	
180"	304241-3-180		304261-3-180		38034-3-180		D36559-3-180	
240"	304241-3-240		304261-3-240		38034-3-240		D36559-3-240	
348"	304241-3-348		304261-3-348		38034-3-348		D36559-3-348	

MORSE / KONGSBERG BULKHEAD and CLAMP PUSH-PULL CABLES

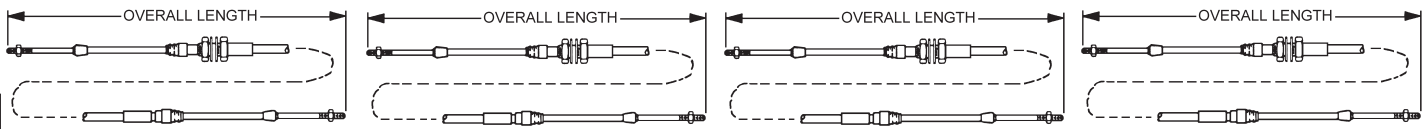

Length	40BC SERIES BULKHEAD/CLAMP TYPE ARMORED STRAND CORE		60BC SERIES BULKHEAD/CLAMP TYPE ARMORED STRAND CORE		80BC SERIES BULKHEAD/CLAMP TYPE ARMORED STRAND CORE		30BC SERIES BULKHEAD/CLAMP TYPE SOLID STAINLESS STEEL CORE	
	Part Number		Part Number		Part Number		Part Number	
36"	304243-3-36		304263-3-36		38023-3-36		D37990-3-36	
48"	304243-3-48		304263-3-48		38023-3-48		D37990-3-48	
84"	304243-3-84		304263-3-84		38023-3-84		D37990-3-84	
96"	304243-3-96		304263-3-96		38023-3-96		D37990-3-96	
108"	304243-3-108		304263-3-108		38023-3-108		D37990-3-108	
120"	304243-3-120		304263-3-120		38023-3-120		D37990-3-120	
156"	304243-3-156		304263-3-156		38023-3-156		D37990-3-156	
168"	304243-3-168		304263-3-168		38023-3-168		D37990-3-168	
348"	304243-3-348		304263-3-348		38023-3-348		D37990-3-348	
360"	304243-3-360		304263-3-360		38023-3-360		D37990-3-360	

VERNIER CABLES
FOR PTO, THROTTLE, CHOKE, DIESEL SHUTOFF and STOP
CAN BE MADE IN 1" - 2" - 3" TRAVEL

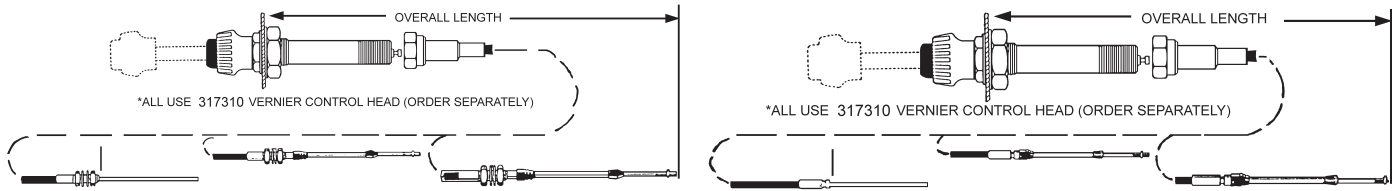

CABLES BUILT TO YOUR SPECIFICATIONS - CALL US FOR PRICE QUOTE

Length Inches	Part Number	Part Number	Part Number	Part Number	Part Number	Part Number
	BULKHEAD With 3" Travel			CLAMP With 3" Travel		
	EXTRA LIGHT DUTY 30L Series	LIGHT DUTY 30 Series 3/16" Thread	STANDARD DUTY 40 Series 1/4" Thread	EXTRA LIGHT DUTY 30L Series	LIGHT DUTY 30 Series 3/16" Thread	STANDARD DUTY 40 Series 1/4" Thread
60	307142-60	307144-3-60	307146-3-60	307143-60	307145-3-60	307147-3-60
120	307142-120	307144-3-120	307146-3-120	307143-120	307145-3-120	307147-3-120
180	307142-180	307144-3-180	307146-3-180	307143-180	307145-3-180	307147-3-180
240	307142-240	307144-3-240	307146-3-240	307143-240	307145-3-240	307147-3-240
300	307142-300	307144-3-300	307146-3-300	307143-300	307145-3-300	307147-3-300
360	307142-360	307144-3-360	307146-3-360	307143-360	307145-3-360	307147-3-360

*317310 CONTROL HEAD FOR ALL VERNIER CABLES LISTED ABOVE

Sequence # 1135165 \$39.66

VERNIER CABLES

**EXTRA LIGHT DUTY WIRE END
30L Series 3" Travel**

60	307141-60
120	307141-120
180	307141-180
240	307141-240
300	307141-300
360	307141-360

**MODULATOR 40 SERIES CABLES
AVAILABLE IN 2" TRAVEL ONLY**

BULKHEAD 1/4" Thread	CLAMP 1/4" Thread
300444-2-60	300441-2-60
300444-2-120	300441-2-120
300444-2-180	300441-2-180
300444-2-240	300441-2-240
300444-2-300	300441-2-300
300444-2-360	300441-2-360

**MODULATOR KIT
For 40 Series Modulator Cables
In Bulkhead or Clamp**

Part #	Sequence #	Each
310821	736738	\$59.43

All Cables on this page are available in variable lengths

MODULATOR INSTALLATION PROCEDURE

ATTACH MODULATOR HOUSING TO CABLE

Add o-ring lube to "O" ring on cable to ease assembly. Insert modulator hub into modulator housing with core fully retracted. Thread setscrew into modulator housing to lock modulator hub into position. Insert the plunger into the snout of the modulator housing from inside the modulator housing cavity ensuring the tapered end of the plunger points to the interior of the cavity as shown.

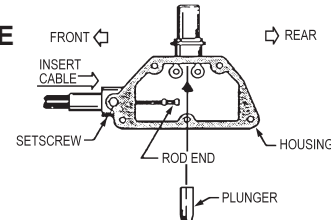

ASSEMBLING A PULL TO OPERATE MODULATOR

Inset the spring into the modulator housing being careful to insert the core into the center of the spring. Compress the spring to the front of the housing. Extend core as shown. Align slot in thimble with core and insert rod end into thimble.

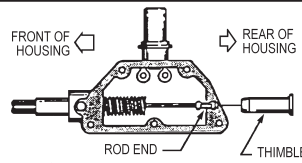

Install lever and spring retainer assembly on the spring as shown. Rotate lever and spring retainer assembly 90 degrees and locate pin in the rear pivot hole.

Note: The word "PULL" on the lever should be visible. Check to ensure all parts move freely.

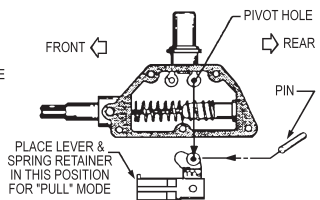

ASSEMBLE A PUSH-TO OPERATE MODULATOR

Insert thimble onto rod end as shown. Compress spring at rear of housing and slide thimble into spring. Install lever and spring retainer assembly as shown. Rotate lever and spring retainer assembly 90 degrees and locate pin in the front pivot hole.

Note: The word "PUSH" on the lever should be visible. Check to ensure all parts move freely.

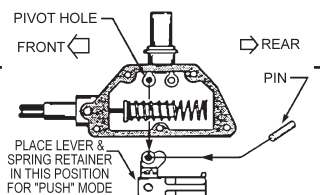
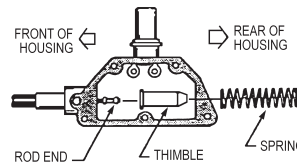

INSTALL COVER

Place the gasket over the modulator housing. Locate the cover pin support hole on the pin and orient screw holes. Insert screws and torque the screws to 35-40 inch pounds. Attach o-ring to modulator housing.

POSITIVE LOCK CABLES
FOR PTO, THROTTLE, CHOKE, DIESEL SHUTOFF and STOP

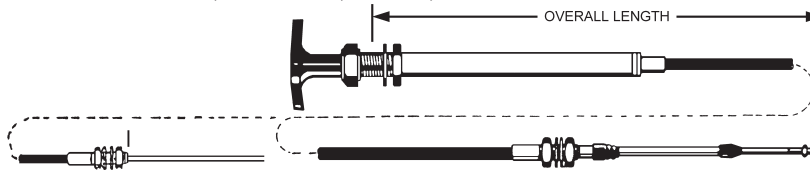

Length Inches	Part Number	Our Sequence Number	Per Each	Part Number	Our Sequence Number	Per Each	Part Number	Our Sequence Number	Per Each
EXTRA LIGHT DUTY BULKHEAD 30L Series 3" Travel			LIGHT DUTY BULKHEAD 30 Series 3" Travel 3/16" Thread			STANDARD DUTY BULKHEAD 40 Series 3" Travel 1/4" Thread			
60	43141-60	DC4830	\$111.67	43143-3-60	DC4890	\$118.36	43145-3-60	DC5228	\$168.89
120	43141-120	DC4832	117.23	43143-3-120	DC4892	123.92	43145-3-120	DC5229	161.49
180	43141-180	DC4834	123.36	43143-3-180	DC4894	130.05	43145-3-180	DC5230	193.88
240	43141-240	DC4836	121.82	43143-3-240	DC4896	128.51	43145-3-240	DC5231	162.00
360	43141-360	DC4838	177.38	43143-3-360	DC4898	184.07	43145-3-360	DC5233	187.05

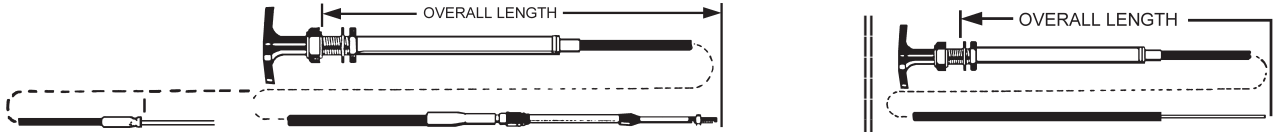

Length Inches	Part Number	Our Sequence Number	Per Each	Part Number	Our Sequence Number	Per Each	Part Number	Our Sequence Number	Per Each			
EXTRA LIGHT DUTY CLAMP 30L Series 3" Travel			LIGHT DUTY CLAMP 30 Series 3" Travel 3/16" Thd			STANDARD DUTY CLAMP 40 Series 3" Travel 1/4" Thd.			EXTRA LIGHT DUTY WIRE END 30L Series 3" Travel			
60	43146-60	DC4900	\$109.58	43142-3-60	DC4860	\$116.27	43144-3-60	DC5207	\$164.28	309367-3-60	736454	\$81.75
120	43146-120	DC4902	115.14	43142-3-120	DC4862	121.83	43144-3-120	DC5208	156.88	309367-3-120	736455	92.53
180	43146-180	DC4904	121.28	43142-3-180	DC4864	127.97	43144-3-180	DC5209	189.26	309367-3-180	736456	103.32
240	43146-240	DC4906	119.74	43142-3-240	DC4866	126.43	43144-3-240	DC5210	157.39	309367-3-240	736457	90.43
360	43146-360	DC4908	175.30	43142-3-360	DC4868	181.99	43144-3-360	DC5212	182.43	309367-3-360	736458	137.90

UTILITY CABLES
FOR PTO, THROTTLE, CHOKE, DIESEL SHUTOFF and STOP

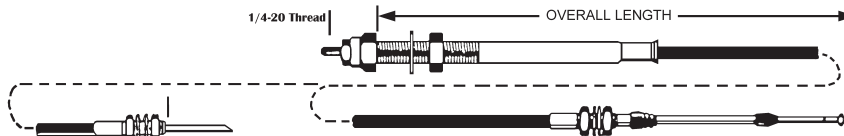

CABLES BUILT TO YOUR SPECIFICATIONS - CALL US FOR PRICE QUOTE

Length Inches	Part Number	Part Number	Part Number		
EXTRA LIGHT DUTY BULKHEAD 30L Series 3" Travel		LIGHT DUTY BULKHEAD 30 Series 3" Travel		STANDARD DUTY BULKHEAD 40 Series 3" Travel	
60	48712-60	38033-3-60	38043-3-60		
120	48712-120	38033-3-120	38043-3-120		
180	48712-180	38033-3-180	38043-3-180		
240	48712-240	38033-3-240	38043-3-240		
300	48712-300	38033-3-300	38043-3-300		
360	48712-360	38033-3-360	38043-3-360		

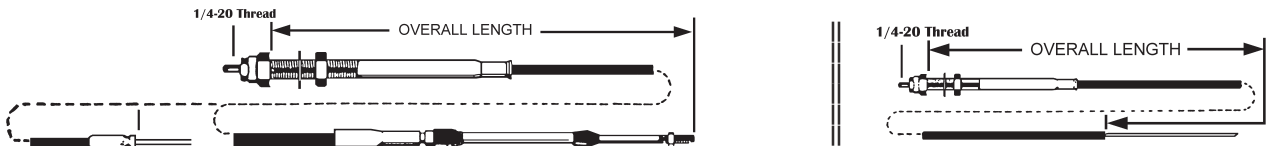

Length Inches	Part Number	Part Number	Part Number				
EXTRA LIGHT DUTY CLAMP 30L Series 3" Travel		LIGHT DUTY CLAMP 30 Series 3" Travel		STANDARD DUTY CLAMP 40 Series 3" Travel		EXTRA LIGHT DUTY WIRE END 30L Series 3" Travel	
60	48713-60	38038-3-60	38046-3-60	48711-60			
120	48713-120	38038-3-120	38046-3-120	48711-120			
180	48713-180	38038-3-180	38046-3-180	48711-180			
240	48713-240	38038-3-240	38046-3-240	48711-240			
300	48713-300	38038-3-300	38046-3-300	48711-300			
360	48713-360	38038-3-360	38046-3-360	48711-360			

ACCELERATOR CABLES

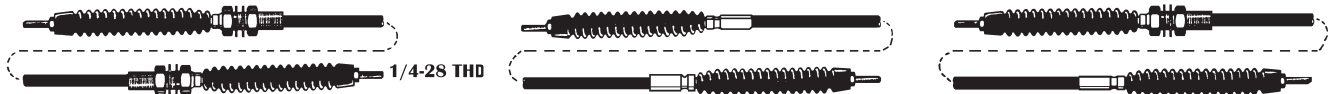

CABLES BUILT TO YOUR SPECIFICATIONS - CALL US FOR PRICE QUOTE

Length Inches	Part Number	Part Number	Part Number		
BULKHEAD 40 Series 3" Travel 1/4" Thread AVAILABLE IN 2" and 3" TRAVEL ONLY		CLAMP 40 Series 3" Travel 1/4" Thread AVAILABLE IN 2" and 3" TRAVEL ONLY		BULKHEAD/CLAMP 40 Series 3" Travel 1/4" Thread AVAILABLE IN 2" and 3" TRAVEL ONLY	
60	68343-3-60	68357-3-60	301127-3-60		
120	68343-3-120	68357-3-120	301127-3-120		
180	68343-3-180	68357-3-180	301127-3-180		
240	68343-3-240	68357-3-240	301127-3-240		
300	68343-3-300	68357-3-300	301127-3-300		
360	68343-3-360	68357-3-360	301127-3-360		

MORSE/KONGSBERG CABLE BUILD ORDER

W7

SALESMAN _____ DATE _____ INVOICE NUMBER: _____

CUSTOMER _____ PAGE _____ OF _____

TOWN _____ STATE _____ ZIP CODE _____

PHONE NO. _____ ORDERED BY _____ P/O # _____ \$ _____ QUOTED PRICE

SHIP BY _____ NEXT DAY 2nd DAY SAT. DEL _____ OUR PART # _____

CUSTOMER PART # _____ WE **DO NOT** MAKE BRAKE CABLES. _____ QUANTITY
(IF AVAILABLE)

USE BACKSIDE OF THIS SHEET FOR VERNIER, UTILITY, OR POSITIVE LOCK CABLES.

PUSH - PULL

END A END B

CLAMP CLAMP

BULK BULK

OVERALL LENGTH _____ INCHES



BULKHEAD - BULKHEAD



CLAMP - CLAMP



BULKHEAD - CLAMP

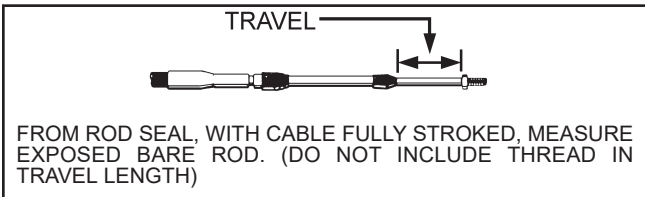

FROM ROD SEAL, WITH CABLE FULLY STROKED, MEASURE EXPOSED BARE ROD. (DO NOT INCLUDE THREAD IN TRAVEL LENGTH)

1" 2" 3" 4" 5"

THREAD

(10-32) 3/16 30 SERIES (Part # Prefix D3)

(1/4-28) 1/4 40 SERIES (Part # Prefix 30424)

(5/16-24) 5/16 60 SERIES (Part # Prefix 30426)

(3/8-24) 3/8 80 SERIES (Part # Prefix 380) **NO 1" TRAVEL**

RVC (REMOTE VALVE CONTROL)

(AVAILABLE IN 40 SERIES ONLY)

END A END B

RVC RVC

CLAMP

42U BULK

OVERALL LENGTH _____ INCHES



TYPE 42UG CABLE

(Part # Prefix 302845-2-XXX) Valve Kit Required



TYPE 42GC CABLE w/SAS SEAL CABLE 1/4-28 THREAD

(Part # Prefix 302486-2-XXX) No Valve Kit Required



TYPE 42GB CABLE w/SAS SEAL CABLE 1/4-28 THREAD

(Part # Prefix 302665-2-XXX) No Valve Kit Required

ORDER CONTROL HEAD & VALVE BONNET KIT SEPARATELY

Use **YOUR CONTROL HANDLE** for these cables

ORDER VALVE BONNET KIT SEPARATELY



42UC 1/4-28 THREAD (Part # Prefix 302909-2-XXX)



42UB 1/4-28 THREAD (Part # Prefix 303197-2-XXX)

TRAVEL - ALL 2 INCHES

THREAD FOR CLAMP OR BULK ONLY: (1/4-28) 1/4

Travel Inches	BULK TYPE MID TRAVEL		CLAMP TYPE MID TRAVEL	
	2"	3"	2"	3"
30 SERIES	5.88"	7.38"	5.19"	6.69"
40 SERIES	6.12"	7.62"	5.50"	7.00"

W8

TRAVEL: WITH HANDLE PUSHED FULLY IN, MEASURE FROM ROD SEAL, EXPOSED ROD.
DO NOT INCLUDE THREAD.

VERNIER

- END A VERNIER END B CLAMP
 VERNIER BULK
- ↓ 30 SERIES ONLY ↓
- 307141 BARE WIRE
 307143 CLAMP BARE WIRE
 307142 BULK BARE WIRE
- OVERALL LENGTH _____ INCHES

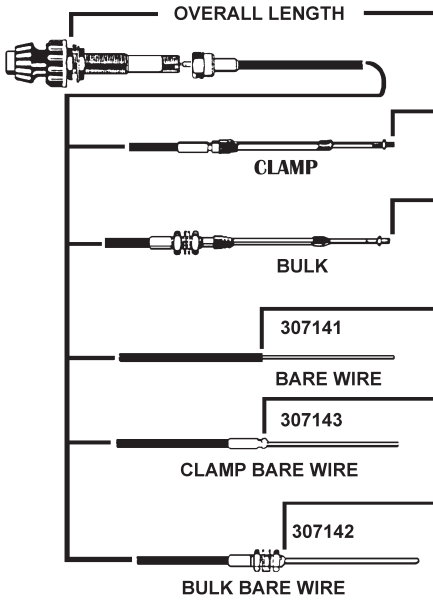

- TRAVEL**
 CLAMP OR BULK ONLY
 1" 2" 3"
 WIRE END HAS 3" ONLY
- THREAD**
 (10-32) 3/16 30 SERIES
 (Part # Prefix 30714)
 (1/4-28) 1/4 40 SERIES
 (Part # Prefix 30714)
 WIRE 30L SERIES
 (Part # Prefix 30714)

MUST ORDER HEAD SEPARATELY:

- 317310

UTILITY

- END A UTILITY END B CLAMP
 UTILITY BULK
- ↓ 30 SERIES ONLY ↓
- 48711 BARE WIRE
 48713 CLAMP BARE WIRE
 48712 BULK BARE WIRE
- OVERALL LENGTH _____ INCHES

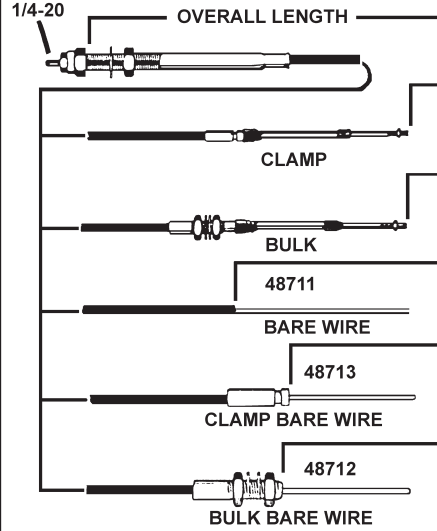

- TRAVEL**
 CLAMP OR BULK ONLY
 1" 2" 3"
 WIRE END HAS 3" ONLY
- THREAD**
 (10-32) 3/16 30 SERIES
 (Part # Prefix 3803)
 (1/4-28) 1/4 40 SERIES
 (Part # Prefix 3804)
 WIRE 30L SERIES
 (Part # Prefix 48711)

MUST ORDER KNOB T-HANDLE SEPARATELY:

- Aluminum T-Handle B37601 1/4-20
 Aluminum T-Handle B38364 1/4-20
 Black Plastic T-Handle B41884 1/4-20
 Black Plastic Knob B43267 1/4-20

POSILOCK

- END A POSILOCK END B CLAMP
 POSILOCK BULK
- ↓ 30 SERIES ONLY ↓
- 309367 BARE WIRE
 43146 CLAMP BARE WIRE
 43141 BULK BARE WIRE
- OVERALL LENGTH _____ INCHES

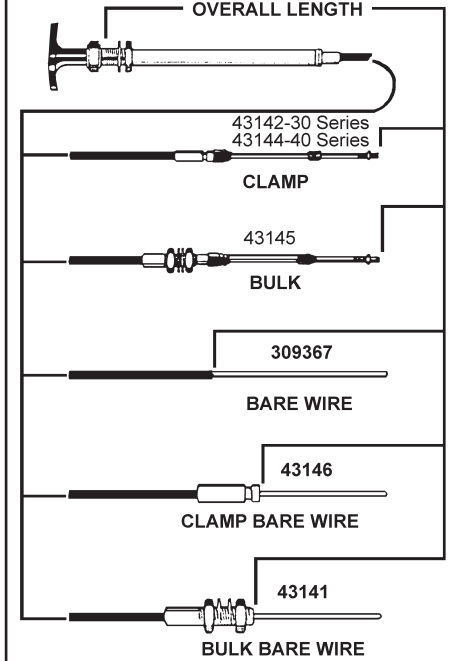

- TRAVEL**
 WIRE END HAS 3" ONLY
- THREAD**
 (10-32) 3/16 30 SERIES
 (Part # Prefix 4314)
 (1/4-28) 1/4 40 SERIES
 (Part # Prefix 4314)
 WIRE 30L SERIES
 (Part # Prefix 309367)

T-HANDLE INCLUDED



40 MODULATOR 42B

TYPE 42B CABLE ONLY (Part # 300444-2 length inches)



42C

TYPE 42C CABLE ONLY (Part # 300441-2 length inches)

MODULATOR KIT

MUST ORDER SEPARATELY

310821

OVERALL LENGTH _____ INCHES

USED ON ALLISON AUTOMATIC TRANSMISSION

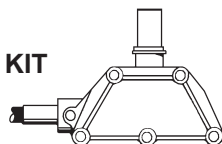

40 ACCELERATOR



40B BULKHEAD 1/4-28 Thread

TYPE 42B CABLE (Part # 68343-2 length inches) 2" Travel 3" Travel



40C CLAMP 1/4-28 Thread

TYPE 42C CABLE (Part # 68357-2 length inches) 2" Travel 3" Travel



40BC BULKHEAD/CLAMP 1/4-28 Thread

TYPE 42BC CABLE (Part # 301127-2 length inches) 2" Travel 3" Travel

OVERALL LENGTH _____ INCHES

AVAILABLE IN 2 AND 3 INCH TRAVEL ONLY

CONTROL CABLES FOR FARM EQUIPMENT

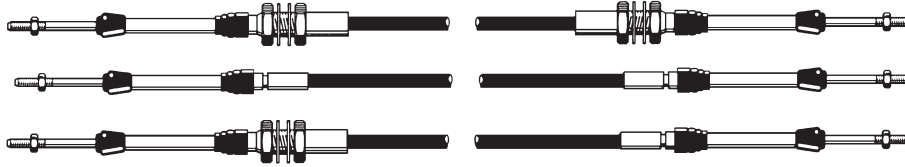

Part Number	Part Number	Part Number	Part Number
ALLIS CHALMERS	CMC	JOHN DEERE FARM EQUIPMENT	FARMHAND
1180699	M8352	WIDROWER, Model No. 2320	302845-000-0076
1180700	M8584	AE37757 (High - Low)	302845-000-0084
1192127	M9120	WINDROWER, Model No. 3320, 2420	7530-2
1304731	M9257	AE37758	7530-3
1326337	M9322	WINDROWER, Model No. 3430, 3830	7530-4
1328811	M9668	AE45890 (Gear Shift)	7597-1
1339931		WINDROWER, Model No. 5200, 5400, 5440, 5460, 5720, 5820	7597-13
		AE29483	7597-14
CASE	JOHN DEERE CONSTRUCTION	COTTON STRIPPER, Model No. 283	7597-15
A59446	AT102246	AN122251	7597-16
A75815	AT102247	AN122033	
D47328	AT102248	COTTON STRIPPER, Model No. 9940	INTERNATIONAL HARVESTER
D52915	AT102284	AN190170	151909C91
H165670	AT103148	AN122252	165507C91
H165688	AT117018	FORAGE HARVESTER, Model # 5200, 5400	193280C1
H169920	AT196237	AE29484 (Shifting Cable)	214885H1
H26220	AT43015	AE29483 (Range)	302702C91
H265470	AT43960	FORAGE HARVESTER, Model No. 5440, 5460, 5720, 5820	344266C91
H329441	AT45532	AH76369 (Hydraulic Stat. Drive)	344267C91
H337659	AT53873	COMBINE, Model No. 3300	354649C91
H358200	AT55621	AH76855 (Gear Shift)	364535C91
H381756	AT60330	COMBINE, Model No. 4400, 4420	371080C91
H381764	AT60406	AH76767 (Gear Shift)	394552C1
H393165	AT62375	AH76769 (Gear Shift)	400753C91
H416123	AT62376	COMBINE, Model No. 6600 GEAR SHIFT	420023C91
H433339	AT63305	AH76830 (Belt Drive)	423078C1
	AT67679	AH76834 (Hydraulic Stat. Drive)	437156C1
H433340	AT69360	SHIFT RANGE	439100C1
H550426	AT74867	AH76831 (Belt Drive Variable)	439101C1
H551705	AT75933	AH76835 (Hydraulic Stat. Drive)	439102C1
H556290	AT80296	AH76369 (Hydraulic Stat. Drive)	439103C1
H559690	AT83335	COMBINE, Model No. 6620 RANGE SHIFT	463510C1
H559708	AT83337	AH94489 (Posi-Torque Drive)	463511C1
H566919	AT83372	AH94491 (Hydraulic Stat. Drive)	484950C91
H569160	AT83373	GEAR SHIFT	503153C91
H588376	AE29483	AH94492 (Hydraulic Stat. Drive)	503607C91
H590166	AE29484	REVERSER CONTROL - 610301	516965C1
H592493	AE37757	AH96717 (Hydraulic Stat. Drive)	518365C1
H592501	AE37758	COMBINE, Model No. 6622	643523C92
H592584	AE45503	HYCYCLE SPRAYER	65887C91
H593798	AE45890	AH97916	660843C91
H593806	AE45890	AH97917	664710C1
H640979	AH76369	AH96718	664844C91
H644401	AH76767	COMBINE, Model No. 7700	767826C91
H645853	AH76769	AH76369 (Hydraulic Stat. Drive)	769857C91
H663641	AH76830	GEAR SHIFT	795705C91
H663658	AH76831	AH76832 (Belt Drive)	796830C1
		AH76836 (Hydraulic Stat. Drive)	863586C2
L101033	AH76832	REVERSER CONTROL	863728C1
L101549	AH76833	AH96717 (Hydraulic Stat. Drive)	864830C1
L110913	AH76834	COMBINE, Model No. 6622	864831C1
L112447	AH76835	HYCYCLE SPRAYER	866687C1
L112448	AH76836	AH97916	867205C1
L112449	AH76837	AH97917	870874C1
L112450	AH76855	AH96718	871300C1
L112451	AH94489	COMBINE, Model No. 7700	871301C1
L114592	AH94490	AH76369 (Hydraulic Stat. Drive)	879044C91
L116740	AH94491	GEAR SHIFT	880133C1
L12450	AH94492	AH76832 (Belt Drive)	
L12487	AH94493	AH76836 (Hydraulic Stat. Drive)	
L14299	AH94494	RANGE SHIFT	
L32679	AH94495	AH76833 (Belt Drive)	
L33717	AH94496	AH76837 (Hydraulic Stat. Drive)	
L35895	AH94497	COMBINE, Model No. 7720 RANGE SHIFT	
L40314	AH94498	AH94493 (Posi-Torque Drive)	
L42534	AH96717	AH94495 (Hydraulic Stat. Drive)	
L42992	AH96718	COMBINE, Model No. 7720 RANGE SHIFT	
L43242	AH97916	AH94495 (Hydraulic Stat. Drive)	
L43243	AH97917	GEAR SHIFT	
L49673	AN122033	AH94494 (Posi-Torque Drive)	
L51160	AN122251	AH94496 (Hydraulic Stat. Drive)	
L60145	AN122252	REVERSER CONTROL	
Q127025	AN190170	AH96717 (Hydraulic Stat. Drive)	
R569160			
S219334			
S225083			
W11224			

CONTROL CABLES FOR HEAVY EQUIPMENT

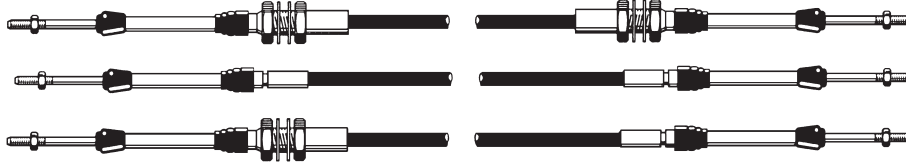

WE HAVE AVAILABLE THE O.E.M. CABLE NUMBERS LISTED ON THE PREVIOUS AND FOLLOWING PAGE. CALL FOR PRICES.

Part Number	Part Number	Part Number	Part Number	Part Number	Part Number	
A.L. LEE CORP. (Mine Equip. Co.) 038011-003-0136.0 038011-003-0144.0 048711-000-060.0 048711-000-0136.0 068357-003-0096.0	Challenge (Cont'd) 1340246 1340247 1340248 1340249 1340250 1340252 1340253 1340254 1340255 1340256 1340257 1340264 1340266 1340267 1340268 1340274 1340275 1340276 1340277 1340282 1340344 1340345 1340346 1340352 1340353 1340355 1340362 1340382 1340397	CLARK (Cont'd) 2550560 2553486 2675546 3675483 3675518 3675546 442344 5204702 5205985 5207413 5207414 5207418 5207455 5308053 5308054 5340177 991134 992538	DIAMOND REO 619-H4 653-H4 695-H4 835-H4 836-H4 882-H4 883-H4 1009-H4 1032-H4 1033-H4 1120-H4 1121-H4 1129-H4 1130-H4 1134-H4 1196-H4 1257-H4 1422-H4	FMC 49J0059 50J0930 50J0974 50J1028 50J1029 59A0576 59A0878 62W3147	INDUSTRIAL IRRIGATION 43820-3-60	
AMERICAN COLEMAN Yardspotters - Airline Two Tugs 22721C9 56186					JAEGER, MCNEILUS, & T.L. SMITH - Cement Mixer MTM00805 MTM00806 MTM00807 MTM00808 MTM00809 MTM00810 MTM00811 MTM00812 MTM00813 MTM00814 MTM00815 MTM00816 MTM00817 MTM00821 MTM00822 MTM00823 MTM00824 MTM00825 MTM00826 MTM00827 MTM00828 MTM00829 MTM00835 MTM00836 MTM00837 MTM00838 MTM00839 MTM00840 MTM00841 MTM00842 MTM00843 MTM00844 MTM00845 MTM00846 MTM00847 MTM00848 MTM00849 MTM00850 MTM00851 MTM00852 MTM00853 MTM00854 MTM00855 MTM00856 MTM00857 MTM00858 MTM00859	
AMERICAN SNOWBLAST 80741 80834 80894 81161		CMC (Mixers) M3119 M8351 M8392 M8393 M8484 M8485 M8486 M8487 M8488 M8684 M9036 M9908	ERICKSON CORP. 27-1539			
ARROW Concrete Hammers - Mobile Unit 4001392 4001557			FEDERAL MOGUL (Target Prod. Div.) Concrete Saws & Road Resurfacers OP700213 OP700330			
BIG A (RICKEL) 015719 027520 028548			FMC A1J0060 18J5313 23658 26A201 28J2204 29F59 31J1886 31J2299 31J2950 31J3024 31J3031 31J391 31J518 32J1929 32J1991 32J996 36A0752 36J1588 36J2206 36J3279 37A1610 37A1611 38J0614 38J1018 39J0663 39J0785 41J0212 41J0364 41J0463 41J1378 41J1381 41J1389 41J1390 41J1412 41J1721 41J1722 41N0361 4183683 43J0940 45F0062 45J1208 46J1404 47F0028 47J2025			
BRODERSON MFG. Mobile Crane and Hammers 0-600-6312 0-600-40188 0-600-40222 0-600-66316	CLARK 1057430 1550181 1550832 1550833 1550834 1564793 1570245 1648244 1648245 1668527 1668528 1668818 1668888 1675930 1668889 1697532 1697533 1701163 1701164 1748430 1748435 1758863 1763229 1763230 1766906 1768340 1779092 1798711 1798712 1906155 1909059 1909952 1914678 1921250 1928460 1929825 1990521 2305072 2305073 2501423 2501424 2506507 2516784 2536709	COLT INDUSTRIES Quincy Compressors 42BC-36 42BC-40 42BC-45 42BC-50 42BC-66 239-0457				
CEDAR RAPIDS, INC. (IOWA MFG.) Road Pavers and Rock Crushers 45675-007-01 45675-007-02 45675-007-003					GMC 2017896 2025698 2046166 687894 688798 693921 697380 698924 702650 724019	
CENTRAL MINING EQUIPMENT 83153 (11 Foot) 83153 (12 Foot)		DART (Curbmaster, Inc.) 43B-8 63B-108 301127-2-216 63B-90 63B-144				
CHALLENGE COOK 1340222 1340228 1340232 1340233 1340234 1340235 1340236 1340237 1340238 1340239 1340240 1340245		DIAMOND REO 2227-H4-323 2227-H4-330 2227-H4-343 2227-H4-345 2227-H4-350 2227-H4-357 2966-T3-1 2966-T3-2 2966-T3-3 2966-T3-4 2966-T3-5 2966-T3-6 592-H4-1 592-H4-2 592-H4-3 592-H4-4 592-H4-5 592-H4-6 592-H4-7 592-H4-8 592-H4-9 592-H4-10 592-H4-11 592-H4-12 594-H4		GROVE CRANE 7246000428 7246000431 7246000446 7246000459 7246000469 7246000472 7246000544 7246000642	JARVIS CLARK (John Clark) 037912-003-0096.0 048711-000-0030.0	
			HELLSTAR CORP. 98-01-015 98-01-028		CABLES BUILT TO YOUR SPECIFICATION CALL US FOR A PRICE QUOTE	

CONTROL CABLES FOR HEAVY EQUIPMENT

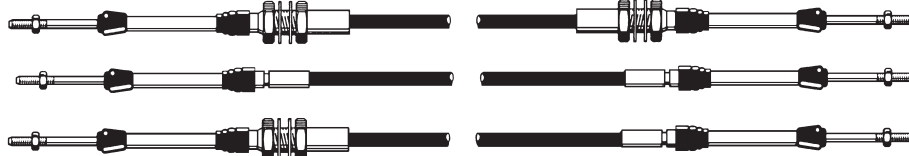

Part Number	Part Number	Part Number	Part Number	Part Number	Part Number
HAGIE Mfg.-Sprayer 785004	HARNISHFEGER (Cont'd)	HYSTER (Cont'd) 393085 75400 82217	MACK TRUCK 27RC229P1 27RC229P2 27RC229P3 27RC229P4 27RC229P5 27RC229P6 27RC229P7 27RC229P8	PITMAN MFG. 267004260	RIMPULL CORP. - Mining Trucks 180-245-156-120 180-245-156-156 2-151-002415
HARNISHFEGER CORPORATION	6Q11-D80 6Q11-D81 6Q11-D82 6Q11-D83	KOEHRING 061080751	27RC29307 27RC29307P2 27RC29307P3 27RC29307P4	REX - Mixers 102-6372-3 102-7244-1 102-7244-2 102-7244-3	RIVINIUS, INC. 60657200 609546000 61105000 61128000
6Q11-D1 6Q11-D2 6Q11-D3 6Q11-D10	6Q156-D2 6Q156-D3 6Q156-D5 6Q156-D6	1291-67 1291-71 1291-73 1291-79	27RC318P1 27RC318P2 27RC318P3 27RC318P5	102-7244-4 102-7244-5 102-7244-6 102-7244-7	T. J. SMITH Railroad Shuttle Wagon - Yardspotter - Cline Truck 2-151-008841 2-151-010302 2-151-013445 2-151-016876 2-151-021139
6Q11-D11 6Q11-D12 6Q11-D13 6Q11-D15	6Q156-D7 6Q156-D8 6Q156-D9 6Q156-D10	1291-80 1291-87 1291-88 1291-89	27RC321P1 27RC321P2 27RC321P3 27RC39304P1	102-7244-8 102-7244-9 102-7244-10 102-7244-11	2-151-022415 2-151-024360 2-151-024901 2-151-027265 2-151-029675
6Q11-D16 6Q11-D17 6Q11-D20 6Q11-D24	6Q156-D11 6Q156-D12 6Q156-D13 6Q156-D14	1291-90 1291-91 1291-93 1291-96	27RC318P6 27RC318P7 27RC318P8 27RC318P9	102-7244-12 102-7244-13 102-7244-14 102-7244-15	2-151-024901 2-151-027265 2-151-029675
6Q11-D27 6Q11-D28 6Q11-D29 6Q11-D30	6Q156-D15 6Q156-D16 6Q156-D17 6Q156-D18	1291-97 1291-98 1291-104 1291-105	27RC320P1 27RC320P2 27RC320P3	102-7244-16 102-7244-17 102-7244-18 102-7244-19	2-151-022415 2-151-024360 2-151-024901 2-151-027265 2-151-029675
6Q11-D31 6Q11-D32 6Q11-D33 6Q11-D34	6Q156-D19 6Q156-D20 6Q156-D21 6Q156-D22	1291-97 1291-98 1291-104 1291-105	27RC321P1 27RC321P2 27RC321P3 27RC39304P1	102-7244-20 102-7244-21 102-7244-22 102-7244-23	TOWMOTOR CORP. 339491 683181
6Q11-D35 6Q11-D36 6Q11-D37 6Q11-D38	6Q156-D23 6Q156-D24 6Q156-D25 6Q156-D26	1291-110 1291-111 1291-113 1291-114	27RC39306 27RC39AP1 27RC39AP2 27RC39AP3	102-7244-24 102-7244-25 102-7554-1 102-7554-2	VERMEER 10609-001 15787-01 2777-001 2778-001
6Q11-D39 6Q11-D40 6Q11-D41 6Q11-D42	6Q156-D27 6Q25901 6Q249010	1291-124 1291-125 1291-127 1291-130	27RC39AP4 27RC39AP5 27RC39AP6	102-7554-3 102-7554-4 102-7554-5 102-7554-6	2779-001 2780-001 2781-001 2782-001
6Q11-D43 6Q11-D44 6Q11-D45 6Q11-D46	HOUGH INTERNAT'L 1213765C1 65887C91 879044C91 880133C1 885321C1	1291-132 1291-133 1291-134 1291-135 1291-136	MCKEE BROTHERS 37913-3-96 38013-3-72	102-7554-7 102-7554-8 107-172-6 107-172-8	2783-001 2807-001 2810-001 64099-001 64100-001
6Q11-D47 6Q11-D48 6Q11-D49 6Q11-D50	HYSTER 125470 132974 133758 180695	1291-144 1291-148 1291-156 1291-166 A130105	MCNEILUS - Mixer 115017 115022	107-172-12 107-282-6 298-00155-47 298-0156-47 298-0221-47	WABCO PB2680 PB3556 PB4278 PB4441
6Q11-D51 6Q11-D52 6Q11-D53 6Q11-D54	181678 184626 203578 213895	KRESS CORP. Mining Equipment 20083 24100 27421	OTTAWA TRUCK - Yardspotter 53109321 53518146 53518147 90001180 90001588 90001589 90714079 SS1295		
6Q11-D55 6Q11-D56 6Q11-D57 6Q11-D58	228155 249288 249440 249776	28715 29324 61227 66243	PETTIBONE CORP. 08-7552 32247-9 CM-23-28 CM-23-44 L-7653 L-7653-4 LA-560-3 LL-3331-1		
6Q11-D59 6Q11-D60 6Q11-D61 6Q11-D62	249777 249778 249779 250783	LOCKWOOD CORP. 117053-5 47540-84 47540-120 L-00541-00101 L-00541-00106	PORTADRILL 038013-003-0084.0 038013-003-0120.0 038013-003-0144.0 038013-003-0156.0 038013-003-0168.0 038013-003-0180.0 038013-003-0200.0 038013-003-0204.0 038013-003-0216.0 038013-003-0260.0 038013-003-0264.0		
6Q11-D63 6Q11-D64 6Q11-D65 6Q11-D66	253821 253822 262468 262469	L00541-0092 L004427-6315 M-04627-03832 PO4754-00072			
6Q11-D67 6Q11-D68 6Q11-D69 6Q11-D70	390317 390318 390396 391661	MACK TRUCK 21QB3158 21QB3158P2 21QB3158P3 27RC150 27RC152			
6Q11-D71 6Q11-D72 6Q11-D73 6Q11-D74 6Q11-D75	391662 391875 391876 392014				
6Q11-D76 6Q11-D77 6Q11-D78 6Q11-D79					

Choose From Three Control Head Mountings

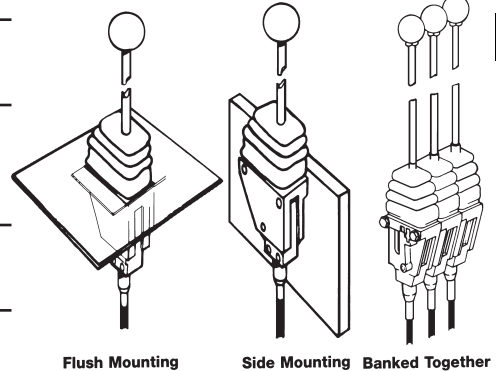

Flush Mounting Side Mounting Banked Together