

# MORSE/TELEFLEX CABLE BUILD ORDER

SALESMAN \_\_\_\_\_ DATE \_\_\_\_\_ INVOICE NUMBER: \_\_\_\_\_

CUSTOMER \_\_\_\_\_ PAGE \_\_\_\_\_ OF \_\_\_\_\_

TOWN \_\_\_\_\_ STATE \_\_\_\_\_ ZIP CODE \_\_\_\_\_

PHONE NO. \_\_\_\_\_ ORDERED BY \_\_\_\_\_ P/O # \_\_\_\_\_ \$ \_\_\_\_\_ QUOTED PRICE

SHIP BY \_\_\_\_\_  NEXT DAY  2nd DAY  SAT. DEL \_\_\_\_\_ OUR PART # \_\_\_\_\_

CUSTOMER PART # \_\_\_\_\_ WE **DO NOT** MAKE BRAKE CABLES. \_\_\_\_\_ QUANTITY (IF AVAILABLE)

USE BACKSIDE OF THIS SHEET FOR VERNIER, UTILITY, OR POSITIVE LOCK CABLES.

## PUSH - PULL

END A                      END B

CLAMP             CLAMP

BULK              BULK

OVERALL LENGTH \_\_\_\_\_ INCHES

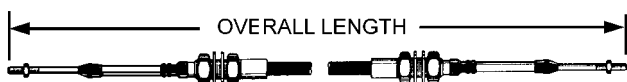

BULKHEAD - BULKHEAD

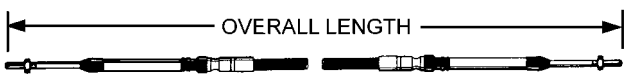

CLAMP - CLAMP

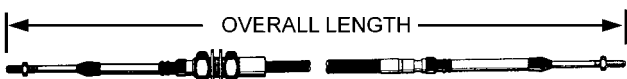

BULKHEAD - CLAMP

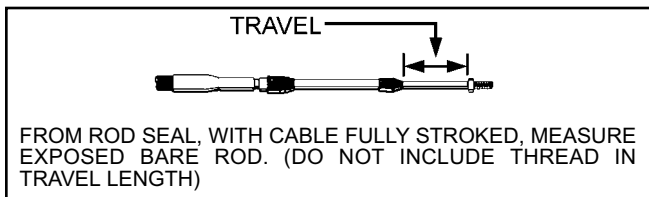

1"  2"  3"  4"  5"

## THREAD

(10-32) 3/16  30 SERIES (Part # Prefix D3)

(1/4-28) 1/4  40 SERIES (Part # Prefix 30424)

(5/16-24) 5/16  60 SERIES (Part # Prefix 30426)

(3/8-24) 3/8  80 SERIES (Part # Prefix 380) **NO 1" TRAVEL**

## RVC (REMOTE VALVE CONTROL)

(AVAILABLE IN 40 SERIES ONLY)

END A                      END B

RVC                        RVC

                           CLAMP

42U                        BULK

OVERALL LENGTH \_\_\_\_\_ INCHES



TYPE 42UG CABLE (Part # Prefix 302845-2-XXX) Valve Kit Required

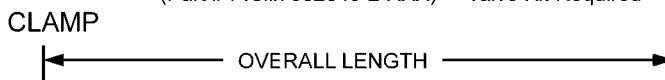

TYPE 42GC CABLE w/SAS SEAL CABLE 1/4-28 THREAD (Part # Prefix 302486-2-XXX) No Valve Kit Required

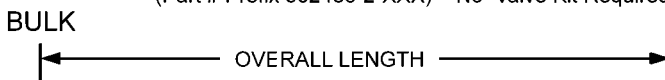

TYPE 42GB CABLE w/SAS SEAL CABLE 1/4-28 THREAD (Part # Prefix 302665-2-XXX) No Valve Kit Required

ORDER CONTROL HEAD & VALVE BONNET KIT SEPARATELY

Use **YOUR CONTROL HANDLE** for these cables ORDER VALVE BONNET KIT SEPARATELY



42UC 1/4-28 THREAD (Part # Prefix 302909-2-XXX)



42UB 1/4-28 THREAD (Part # Prefix 303197-2-XXX)

**TRAVEL - ALL 2 INCHES**

**THREAD** FOR CLAMP OR BULK ONLY: (1/4-28) 1/4

ACCELERATOR CABLE DIMENSIONS				
	BULK TYPE MID TRAVEL		CLAMP TYPE MID TRAVEL	
Travel Inches	2"	3"	2"	3"
30 SERIES	5.88"	7.38"	5.19"	6.69"
40 SERIES	6.12"	7.62"	5.50"	7.00"

TRAVEL: WITH HANDLE PUSHED FULLY IN, MEASURE FROM ROD SEAL, EXPOSED ROD.  
DO NOT INCLUDE THREAD.

**VERNIER**

- END A VERNIER       END B CLAMP   
 CLAMP   
 BULK   
**30 SERIES ONLY**  
 307141 BARE WIRE   
 307143 CLAMP BARE WIRE   
 307142 BULK BARE WIRE

OVERALL LENGTH \_\_\_\_\_ INCHES

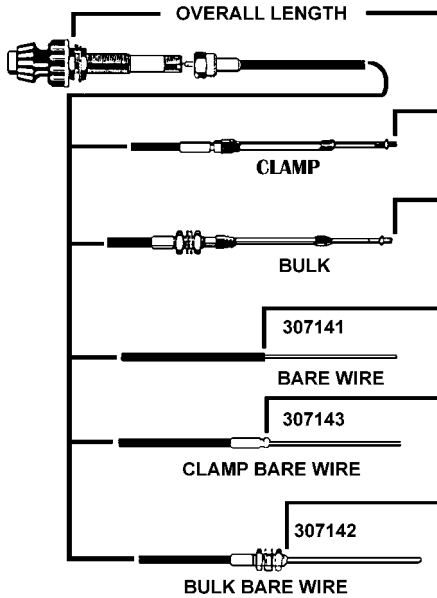

- TRAVEL**  
 CLAMP OR BULK ONLY  
 1"  2"  3"   
 WIRE END HAS 3" ONLY

- THREAD**  
 (10-32) 3/16  30 SERIES  
 (Part # Prefix 30714)  
 (1/4-28) 1/4  40 SERIES  
 (Part # Prefix 30714)  
 WIRE  30L SERIES  
 (Part # Prefix 307141)

MUST ORDER HEAD SEPARATELY:

- 317310

**UTILITY**

- END A UTILITY       END B CLAMP   
 CLAMP   
 BULK   
**30 SERIES ONLY**  
 48711 BARE WIRE   
 48713 CLAMP BARE WIRE   
 48712 BULK BARE WIRE

OVERALL LENGTH \_\_\_\_\_ INCHES

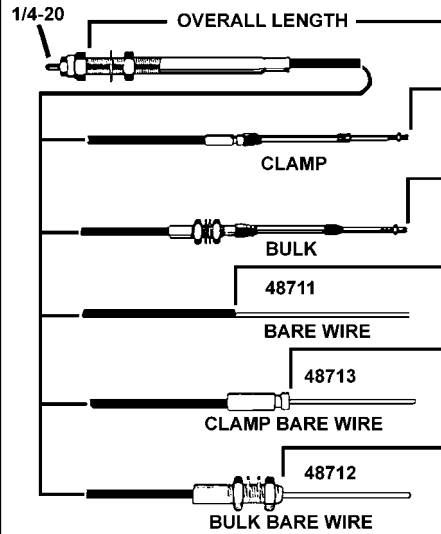

- TRAVEL**  
 CLAMP OR BULK ONLY  
 1"  2"  3"   
 WIRE END HAS 3" ONLY

- THREAD**  
 (10-32) 3/16  30 SERIES  
 (Part # Prefix 3803)  
 (1/4-28) 1/4  40 SERIES  
 (Part # Prefix 3804)  
 WIRE  30L SERIES  
 (Part # Prefix 48711)

MUST ORDER KNOB T-HANDLE SEPARATELY:

- |                        |        |                          |        |
|------------------------|--------|--------------------------|--------|
| Aluminum T-Handle      | B37601 | <input type="checkbox"/> | 1/4-20 |
| Aluminum T-Handle      | B38364 | <input type="checkbox"/> | 1/4-20 |
| Black Plastic T-Handle | B41884 | <input type="checkbox"/> | 1/4-20 |
| Black Plastic Knob     | B43267 | <input type="checkbox"/> | 1/4-20 |

**POSILOCK**

- END A POSILOCK       END B CLAMP   
 CLAMP   
 BULK   
**30 SERIES ONLY**  
 43820 BARE WIRE   
 43146 CLAMP BARE WIRE   
 43141 BULK BARE WIRE

OVERALL LENGTH \_\_\_\_\_ INCHES

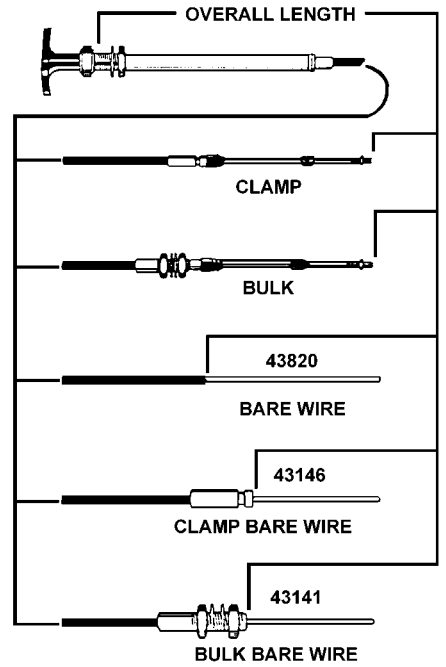

- TRAVEL**  
 WIRE END HAS 3" ONLY

- THREAD**  
 (10-32) 3/16  30 SERIES  
 (Part # Prefix 4314)  
 (1/4-28) 1/4  40 SERIES  
 (Part # Prefix 4314)  
 WIRE  30L SERIES  
 (Part # Prefix 43820)

T-HANDLE INCLUDED

**40 MODULATOR**



42B

TYPE 42B CABLE ONLY  
 (Part # 300444-2 length inches)



42C

TYPE 42C CABLE ONLY  
 (Part # 300441-2 length inches)

**MODULATOR KIT**

MUST ORDER SEPARATELY

- 310821

OVERALL LENGTH \_\_\_\_\_ INCHES

USED ON ALLISON AUTOMATIC TRANSMISSION

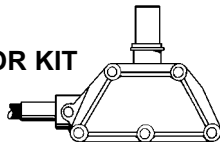

**40 ACCELERATOR**

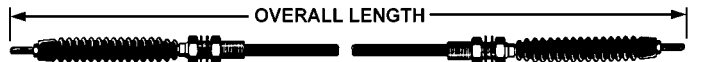

40B BULKHEAD 1/4-28 Thread

TYPE 42B CABLE  
 (Part # 68343-2 length inches)  2" Travel  3" Travel



40C CLAMP 1/4-28 Thread

TYPE 42C CABLE  
 (Part # 68357-2 length inches)  2" Travel  3" Travel



40BC BULKHEAD/CLAMP 1/4-28 Thread

TYPE 42BC CABLE  
 (Part # 301127-2 length inches)  2" Travel  3" Travel

OVERALL LENGTH \_\_\_\_\_ INCHES

AVAILABLE IN 2 AND 3 INCH TRAVEL ONLY